

Dreamland

SLEEPWELL
HEATED MATTRESS
COVER



Operating instructions

DIAGRAMS

[A]

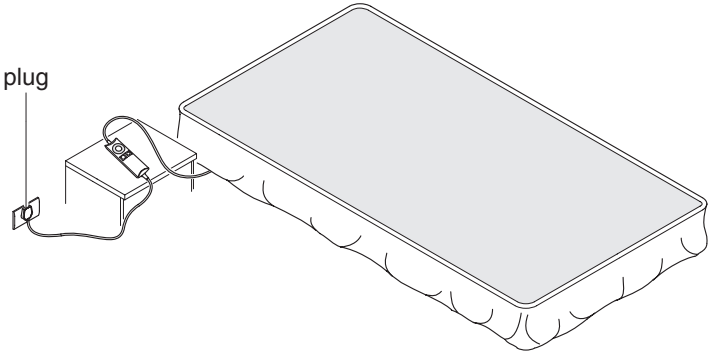

[B]

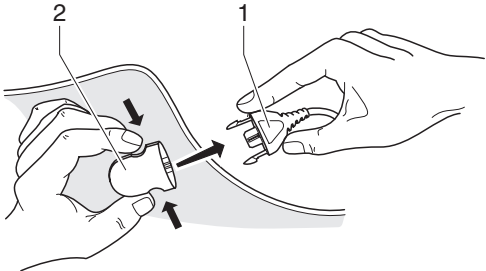

DIAGRAMS

[C]

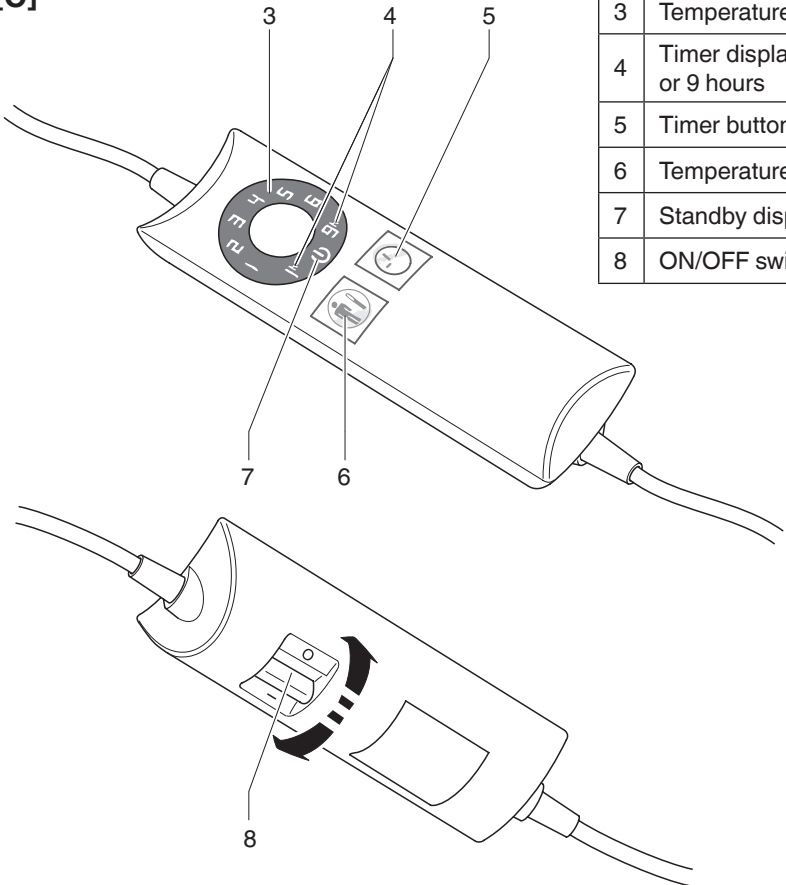

3	Temperature display
4	Timer display 1 hour or 9 hours
5	Timer button
6	Temperature button
7	Standby display
8	ON/OFF switch

[D]

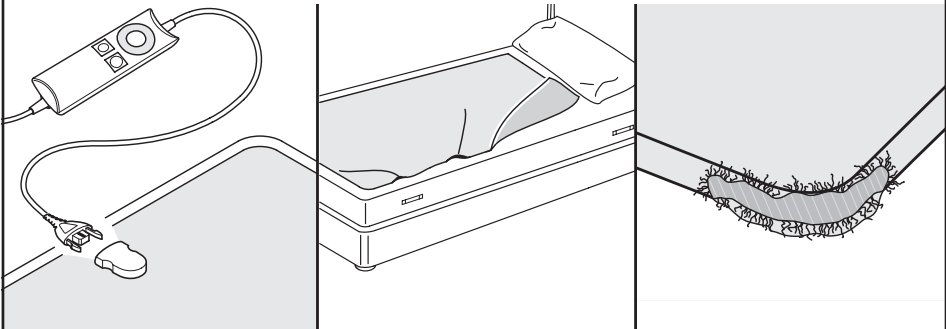

SPECIFICATIONS

Dreamland
TYPE F2115

UNDERBLANKET
220-240 V 50Hz 150 W



Dreamland
TYPE F2111

UNDERBLANKET
220-240 V 50Hz 150 W



Dreamland
TYPE F2112

UNDERBLANKET
220-240 V 50Hz 2x150 W



Dreamland
TYPE F2113

UNDERBLANKET
220-240 V 50Hz 2x150 W



Dreamland
TYPE F2114

UNDERBLANKET
220-240 V 50Hz 2x150 W





OPERATING INSTRUCTION FOR USE OF INTELLIHEAT UNDERBLANKET

Dear Customer, DREAMLAND would like to thank you for purchasing this product. We are convinced that you will appreciate the quality and reliability of this appliance, which was developed and manufactured with customer satisfaction always in mind.

These operating instructions were created based on the European standard EN 62079.

IMPORTANT INSTRUCTIONS RETAIN FOR FUTURE REFERENCE



WARNING!
Instructions and information for safe use.



Please read these instructions completely and in particular the safety instructions before using your appliance and follow these instructions carefully. Keep these instructions and the associated image section in a convenient location for reference over the entire service life of your appliance and be sure to include it if you pass the appliance on to another user.

Should certain parts of this booklet be difficult to understand or should doubts arise, contact the company before using the product, at the address indicated on the last page.

CONTENTS

SAFETY INSTRUCTIONS	page 2
SYMBOL KEY	page 3
POSITIONING AND FITTING INSTRUCTIONS	page 3
USING YOUR BLANKET	page 4
CLEANING AND MAINTENANCE	page 5
STORAGE	page 6
TROUBLE SHOOTING	page 6
AFTER SALE ASSISTANCE	page 7
REGULAR SERVICING	page 7
ELECTRIC BLANKET SERVICE RECORD	page 8
WARRANTY	page 8
DISPOSAL	page 8
DIAGRAMS	I-II
SPECIFICATIONS	III



SAFETY INSTRUCTIONS

- After unpacking, make sure that the appliance is intact with no visible signs of damage caused during transport. Should you have any doubts, do not use the appliance and return it to the authorised Service Centre.
- Packaging materials are not toys! Keep plastic bags away from babies and small children as they pose a suffocation risk!
- Before connecting the appliance, check that the label specifications correspond to the electrical mains supply; the rating is located on the label stitched onto the appliance.
- This appliance must only be used as an underblanket for domestic use as indicated in the instructions. Any other use is to be considered hazardous.
- This appliance is not intended for use by persons (including children) with reduced physical, sensorial or mental capabilities, or lack of experience and knowledge, unless they have been given supervision or instruction concerning use of the appliance by a person responsible for their safety.

Children should be supervised to ensure that they do not play with the appliance.

Particularly do not use the underblanket with the infirm, infants or persons insensitive to heat.

This appliance is not to be used by young children unless the controls have been pre-set by a parent or guardian, or unless the child has been adequately instructed on how to operate the controls safely.

-  NOT to be used by very young children (0-3 years). Children under the age of three are not to use this appliance due to their inability to react to overheating.
-  DO NOT handle the control switch with wet hands.
-  DO NOT pull the power cord or the appliance to remove the plug from the socket.
- Always disconnect the appliance from the mains supply before carrying out any maintenance or cleaning.
- Should the appliance protection fuse break down and/or fail to work properly, turn off the appliance and check the fuse, but do not tamper with it. For any repairs, return it to the authorised Service Centre.
- If the supply cord is damaged, the control unit must be replaced by the authorised Service Centre in order to avoid a hazard.
- The appliance must only be used with the type of controls which are marked on the label of the appliance.
- Avoid placing the control switch below the pillow or between the sheets or blankets when the appliance is connected.
- Examine the appliance frequently for signs of wear or damage. If there are such signs or if the appliance has been misused, return in to the supplier prior to any further use.









ATTENTION!









It is recommended that people with pacemakers do not use the heated bedding for all night use. It may be used to preheat the bed but the heated bedding must be switched off and un-plugged from the socket before going to bed. Please check with the cardiologist.

**ATTENTION!**

If the appliance is used on an adjustable bed, check that the blanket and cord do not become trapped or rucked, for example in hinges.

-  DO NOT tuck in.
-  This appliance is not designed for medical use in hospital.
-  DO NOT use if wet.
-  DO NOT allow pets on the appliance.
-  DO NOT use if folded or crumpled
-  DO NOT insert needles or pins

SYMBOL KEY

	Protection class II / Double insulated
	Caution
	Forbidden
	Temperature selection
	Timer selection
	Stand by
	OFF position
	ON position

POSITIONING AND FITTING INSTRUCTIONS

POSITIONING THE MATTRESS COVER (Diagram [A])

**ATTENTION!**

Place the blanket only within the mattress and the sheet and not over people in bed.

GB

Place the fitted mattress cover directly onto the mattress. Fit the blanket to the mattress and turn the edges of the skirt under the mattress.

FITTING INSTRUCTIONS

Join the connector(s) (1) of the control unit to the connector (2) on the blanket. Ensure the connector is pushed home until the locking catch engages. (Diagram [B])

USING YOUR BLANKET

Your Dreamland Intelliheat mattress cover is designed to FAST PREHEAT your bed and it also responds to temperature changes while you sleep.



The digital Intelliheat control has 6 temperature settings (diagram [C]):

TEMPERATURE SETTINGS		AVERAGE TEMPERATURE**	FEELING
FAST PREHEAT	6	READY FOR BED IN MINUTES	
ALL NIGHT USE *	5	36° C	Ideal for extreme cold conditions
	4	32° C	Ultra warmth for total body relaxation
	3	28° C	Perfect condition for deep and restful sleep
	2	25° C	Ideal to warm up cold feet, extra warmth around lower section of blanket
	1	21° C	For minimal heat, ensure the bed remains dry and hygienic

Temperature laboratory tested following EN60335-2-17

* As set by the latest European standards (EN60335-2-17 the max temp. for all night use cannot be higher than 37°C).

** The Temperature may vary of $\pm 10\%$.

- Connect the plug into the mains socket (Diagram [A]).
- Switch on your the electric blanket, from the back of the control, by positioning the switch ON (I) (8) (Diagram [C])
- **FAST PREHEAT** - the Intelliheat technology automatically sets the control to fast heat up, your bed will be pleasantly warm within a few minutes.
Never use on FAST PRE-HEAT setting 6 whilst in bed.
If your blanket is on stand by, to activate fast pre heat, push the temperature button  (6) until the number 6 on the temperature display (3) (Diagram [C]) is illuminated red.
- **For ALL NIGHT USE** or continuous use, just select your preferred temperature setting from 1 – 5 by simply pushing the temperature button  (6) (Diagram [C]) until the temperature setting desired will light up on the temperature display (3) with an orange glow.

MEMORY FUNCTION

After a few minutes of use your Dreamland Intelliheat blanket will keep in memory your last heat setting.

SWITCH ON/OFF

- ON - To switch the electric blanket on, switch to ON position (I) on the back of the control (14) (Diagram [C]), and select your required temperature and timer.

- OFF - To switch off the electric blanket, switch to OFF position (○) (8) (Diagram [C]), on the back of the control.

AUTO OFF FUNCTION

The appliance is fitted with an AUTOMATIC SHUT OFF system. You have a choice of either 1 hour or 9 hours timer.

- TIMER - Push the timer button ⊕ (5) (Diagram [C]) until either 1 hour or 9 hours is illuminated with a green light (4).
- TIMER OFF - When the timer period has elapsed, the blanket will be switched off and the stand-by display ⊖ (7) (Diagram [C]) will be illuminated with a blue light.

DISCONNECT

- To disconnect your electric blanket from the mains, switch the control to OFF position (○) (8) (Diagram [C]), and then safely disconnect the plug from the main socket (Diagram [A]).

CLEANING AND MAINTENANCE

WASHING INSTRUCTIONS

The Dreamland mattress cover is suitable for washing.

WASHING

1. Prior to washing disconnect the control lead from the blanket, as in Diagram [B].
2. Before washing the blanket it is **essential** that you measure it, to ensure that it is stretched to approximately its original size during the drying process.

MACHINE WASH



The mattress cover may be washed in a washing machine at 40° C on a wool programme.

~~NEVER DRY CLEAN~~

Spin dry on wool programme only. DO NOT use an extra spin cycle.

HAND WASH

1. Use a mild washing powder or detergent and luke warm water to soak your blanket for 15 minutes. After soaking, gently wash the blanket and rinse thoroughly with clean, lukewarm water.
2. Allow the excess water to drain from the blanket. It may also be gently squeezed, but never wring the blanket.

DRYING

1.  Tumble dry on low settings.
2. Air dry on a clothes line, but do not use clothes pegs on the wired area of the blanket as they may damage it.
3. DO NOT use your blanket until it is completely dry.

 NO BLEACH

 Do not iron

GB

STRETCHING

1. The mattress cover must be stretched back to approximately its original size during the drying process. This is best done whilst damp, working from side to side, stretching a strip at a time. This procedure may need to be repeated a few times until fully dry.
2. Inspect the blanket to ensure that none of the wires have formed into loops, or become twisted back on themselves. Holding the blanket up to the light will make it easier to inspect the wires.
3. If any problems with the wires persist after the stretching process, or the blanket does not return to close to its original size, return it along with the control to our Service Centre for a safety inspection.

STORAGE

When not in use store as follows:



ATTENTION!

When storing the appliance, allow it to cool down before folding.



ATTENTION!

Avoid creasing the appliance.



ATTENTION!

Do not place heavy items on the blanket when in storage, as deep creases or folds may damage the wiring.



ATTENTION!

Do not use any moth proofing chemicals.

TROUBLE SHOOTING

These appliances are built to the very highest of standards. There are no user serviceable parts. Follow the solutions if the unit fails to operate.

Problem	Solution
The light fails to illuminate on the control	Check the switch is attached and that the instructions have been followed correctly
	Check fuse has not blown
	Check mains supply is functional
	Check that the blanket control is "ON"
	Discontinue use and return it to our Service Centre for a safety inspection.

Problem	Solution
The  stand by light on the control is flashing	Check that the blanket connection is pushed fully home
	Blanket or control is faulty. If the blanket is damaged, discontinue use and return it to our Service Centre for a safety inspection.
The supply cord or any wiring is damaged	The appliance must be returned to the Service Centre for replacement to prevent a hazard. Do not attempt to repair it yourself.
Damage to the control switch	Discontinue use and return it to our Service Centre for a safety inspection.
Fabric rucking or creasing	Discontinue use and return it to our Service Centre for a safety inspection.
Wear or tear on the fabric	Discontinue use and return it to our Service Centre for a safety inspection.
Heat discolouration of fabric	Discontinue use and return it to our Service Centre for a safety inspection.
The product has been misused or accidentally damaged	Discontinue use and return it to our Service Centre for a safety inspection.

AFTER SALE ASSISTANCE

1. Pack it carefully.
2. Enclose your name, address and day time telephone number.
3. Give the reason why you are returning it.
4. If within the guarantee period, state where and when it was purchased and **include a valid proof of purchase. (e.g. receipt).**
5. Send it to our Service Centre at the address below.

SERVICE CENTRE

PO BOX 166 - Middlewich - Cheshire - CW10 0ZU - Tel: 01606 837222

E- mail: customerservice@imetec.co.uk - www.dreamlanduk.co.uk

REGULAR SERVICING

The appliance must be repaired at the manufacturer's Service Centre, The defective appliance, if under guarantee, must be sent to the Service Centre for replacement repairs with a proper receipt or invoice that attests the date of sale or purchase.

Your blanket should be returned for a safety inspection at least once every 3 years. It should be suitably packed with control, lead and original fitted plug. To ensure minimum inconvenience, please return your blanket for routine safety inspection between April and September.

SERVICE CENTRE

PO BOX 166 - Middlewich - Cheshire - CW10 0ZU - Tel: 01606 837222

E- mail: customerservice@imetec.co.uk - www.dreamlanduk.co.uk

ELECTRIC BLANKET SERVICE RECORD

DATE OF PURCHASE	
DATE FIRST SERVICE DUE (3 years from the purchase date)	DATE SENT
DATE SECOND SERVICE DUE (within 3 years of first service)	DATE SENT

WARRANTY

This product is guaranteed for a period of 3 years from the date of purchase against material, mechanical and electrical defects. The warranty is binding if it is accompanied by a valid receipt of payment. This guarantee is only valid if the appliance is used solely for domestic purposes in accordance with the instructions provided that is not connected to an unsuitable electricity supply, dismantled, interfered with in any way, damaged, through misuse, fair wear and tear. Under this guarantee we undertake to repair or replace free of charge any parts found to be defective.

PLEASE NOTE, THE COST OF A SAFETY INSPECTION IS NOT COVERED BY THIS GUARANTEE. A CHARGE WILL BE MADE IN RESPECT OF ANY PRODUCT RETURNED UNDER THIS GUARANTEE, WHERE NO FAULT IS FOUND.

This guarantee is offered as an extra benefit and does not affect your statutory rights as a consumer. This guarantee does not confer any rights other than those expressly set out above and in particular we shall not be liable for any indirect or consequential loss or damage.

Nothing in this guarantee or the instructions relating to the product excludes, restricts or otherwise affects your statutory rights. In line with our policy of continuous development, we reserve the right to change this product, packaging and documentation without notice. If a defect appears and after checking that the blanket is being used properly in accordance with the instructions, return it with a valid proof of purchase, as soon as possible to the manufacturer's Service Centre. This guarantee is valid in the UK only.

Customer Service - PO BOX 166 - Middlewich - Cheshire - CW10 0ZU - Tel: 01606 837222
E- mail: info@imetec.co.uk - www.dreamland.uk.co.uk

DISPOSAL

The product packaging consists of recyclable materials. Dispose of these in an environmentally appropriate manner.



In accordance with EU directive 2002/96/EC, the appliance must be disposed of properly at the end of its service life.



This involves the recycling of valuable substances contained within the appliance and reduces the impact on the environment. For more information, contact your local disposal company or the store where you purchased the appliance.

Dreamland

M1000511
0311 (MMYY)